

## *FIC Fan Range Details*

The "Finna Inline Centrifugal" fan range is a Forward Curve Inline Centrifugal fan capable of producing moderate volumes with moderate pressures.

### FIC duty range

- Volumes up to 15,000 m<sup>3</sup>/hr
- Pressures up to 1,250 Pa

### FIC fan sizes range from

- 250 mm - 500 mm as standard.
- Larger sizes available on request

### Fan casing materials

- Polypropylene
- Fire Retardant Polypropylene
- UPVC
- UPVC/GRP

### Impeller materials

- UPVC
- Polypropylene
- PVDF

### Motor plate support

- Polypropylene
- UPVC

### Fixings

- A2 stainless steel minimum

### Performance data

- In accordance with BS EN ISO 5801
- Category D test. Ducted inlet, ducted outlet
- Witness testing available upon request

## FIC 250 - 500 Dimension Details

### Dimensions

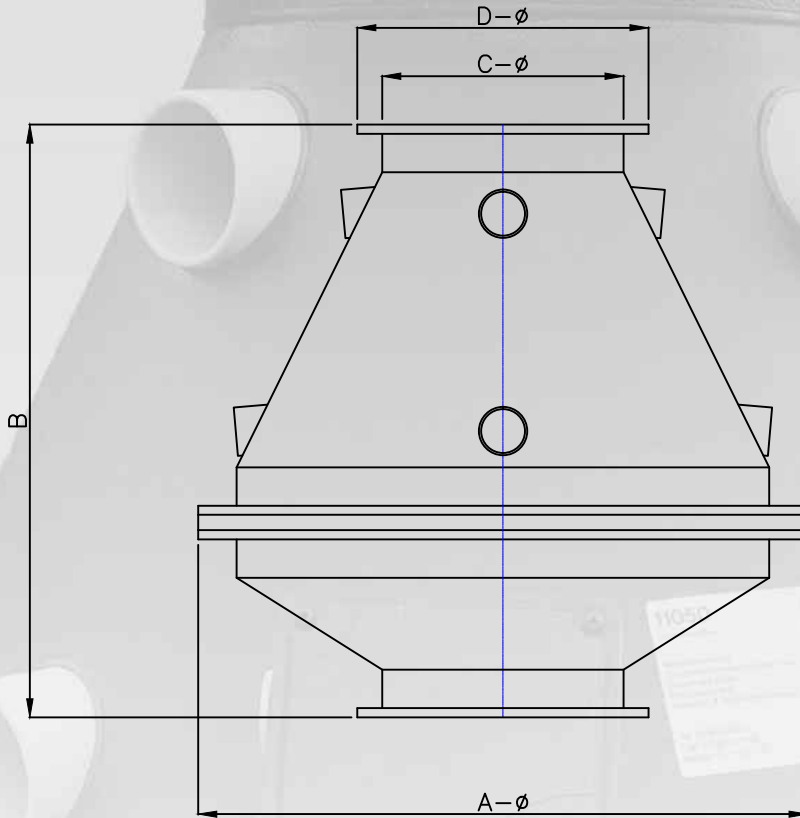

E - PCD

F - no off holes

G - dia holes

### Dimension details

Fan Size	A	B	C	D	E	F	G
250/200	645	665	250	320	290	12	9
250/225	645	665	250	320	290	12	9
250/250	645	665	250	320	290	12	9
315/280	795	760	315	380	350	12	9
315/315	795	760	315	380	350	12	9
400/400	870	810	400	488	448	16	9
450/450	978	910	450	550	505	16	11
500/500	1087	1010	500	600	555	16	11

### FIC 250/200 Performance Curve

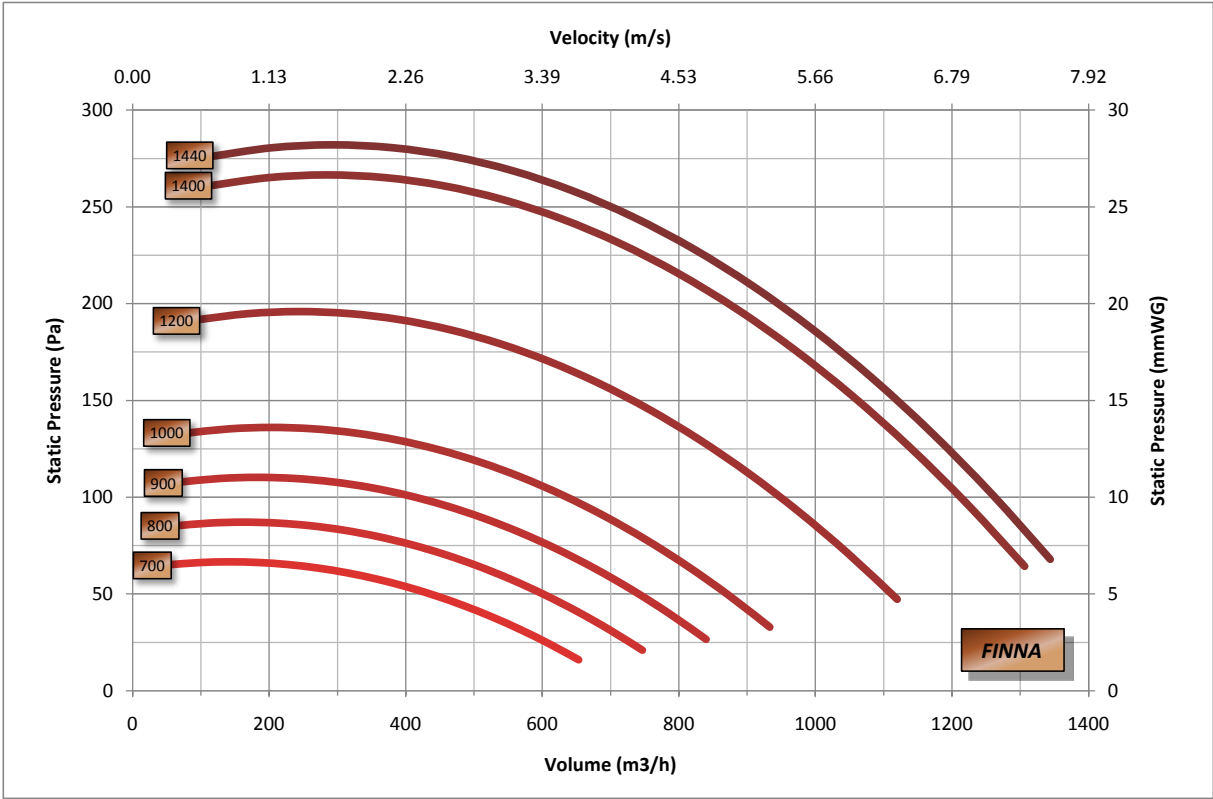

### FIC 250/200 Power / Efficiency Curve

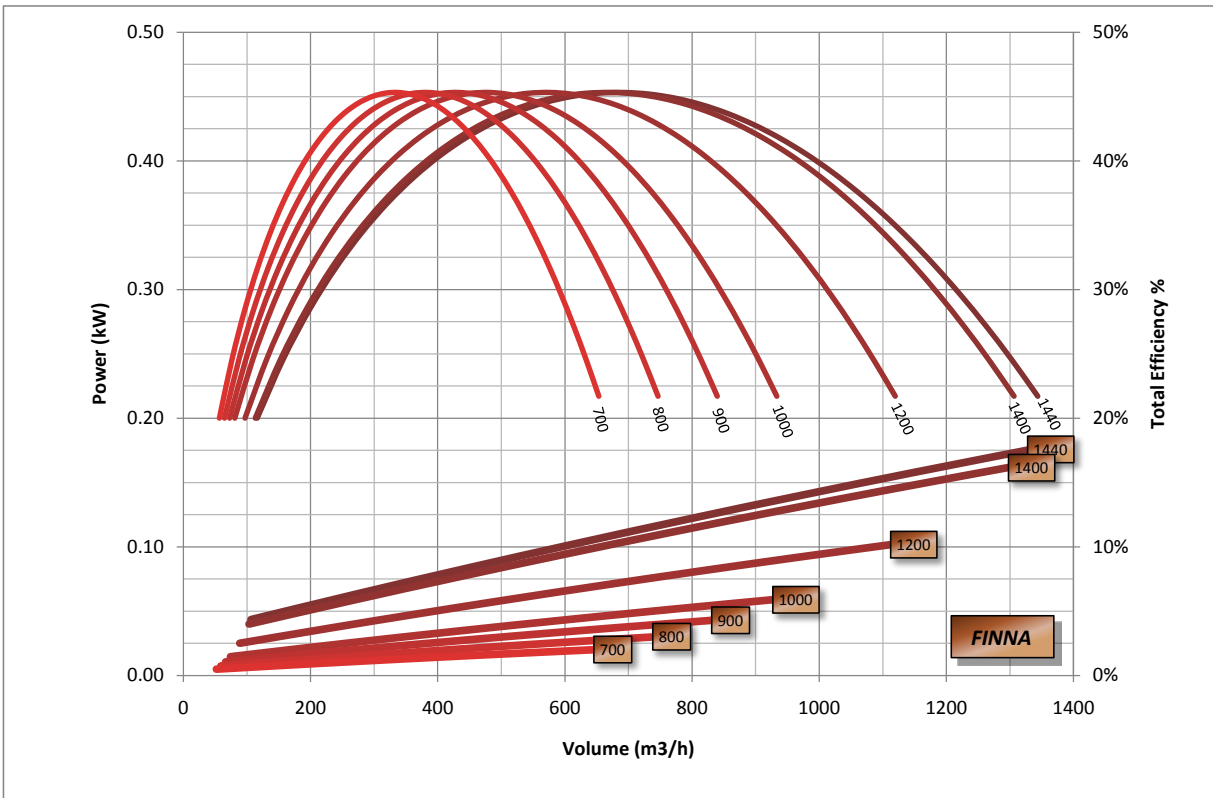

### FIC 250/225 Performance Curve

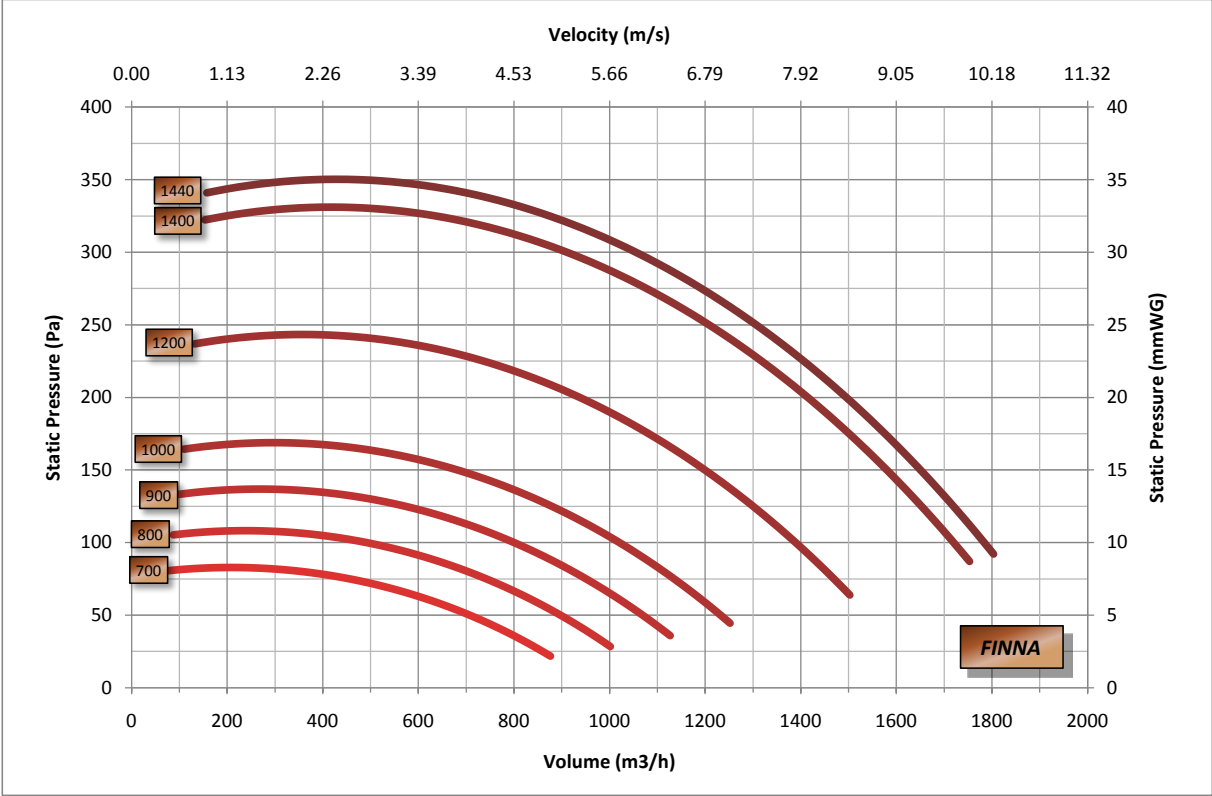

### FIC 250/225 Power / Efficiency Curve

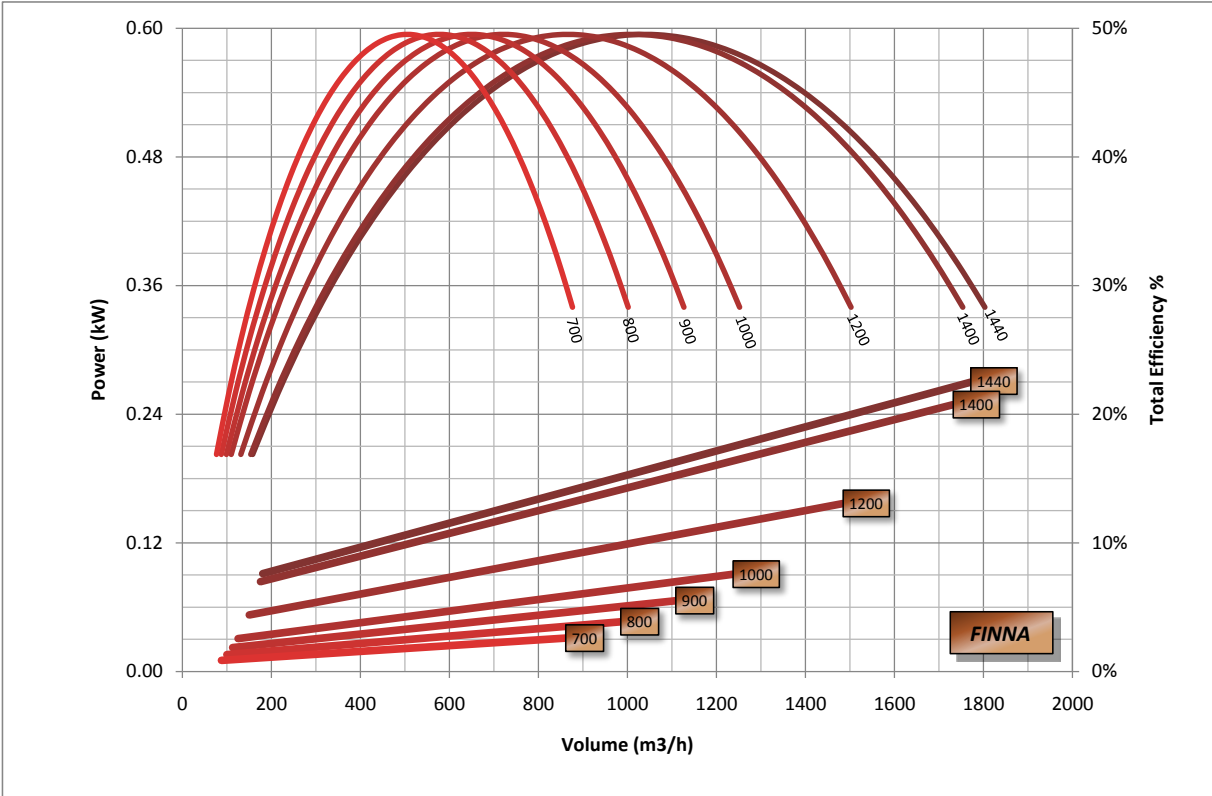

### FIC 250/250 Performance Curve

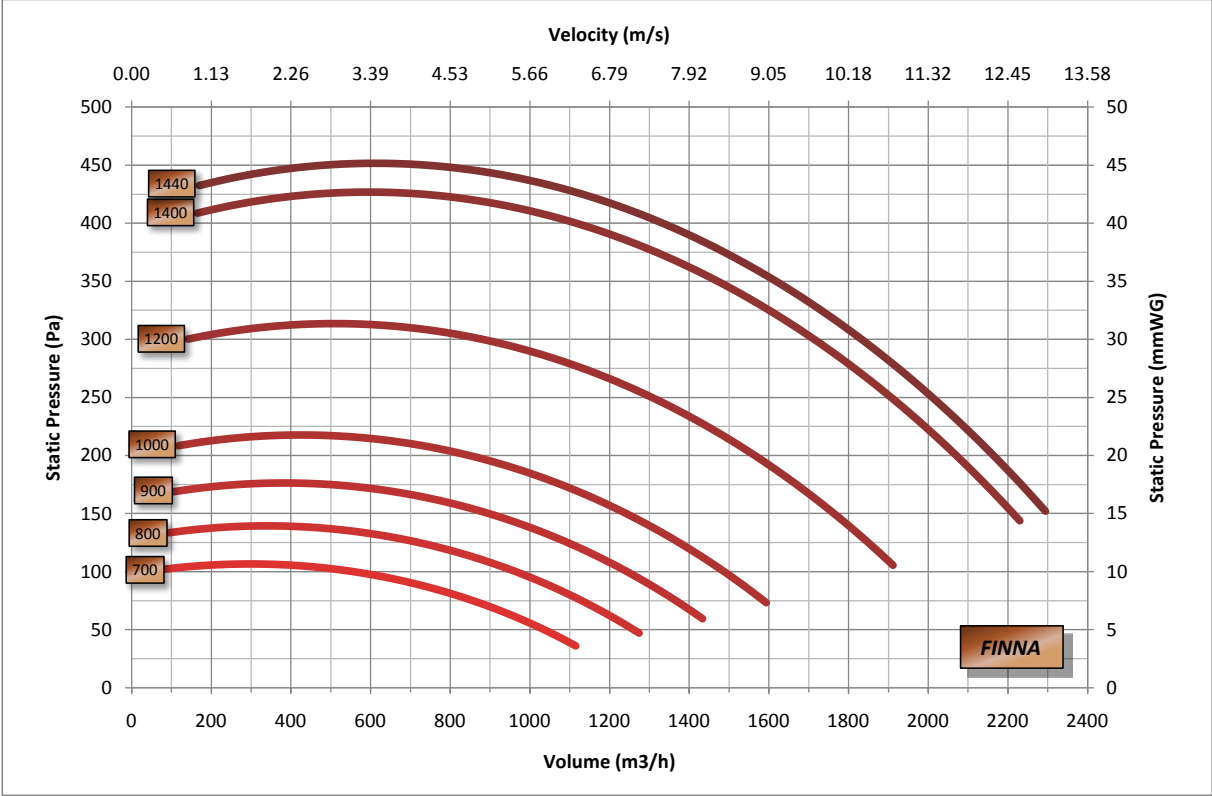

### FIC 250/250 Power / Efficiency Curve

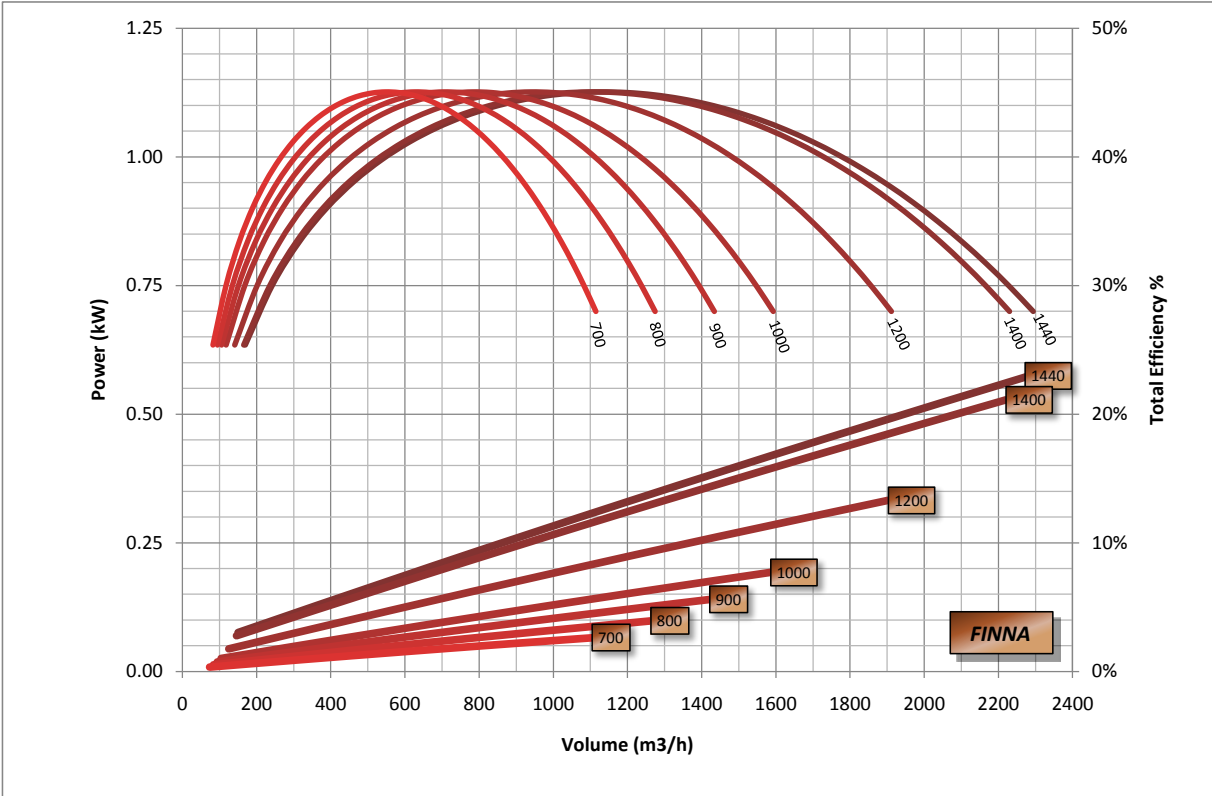

### FIC 315/280 Performance Curve

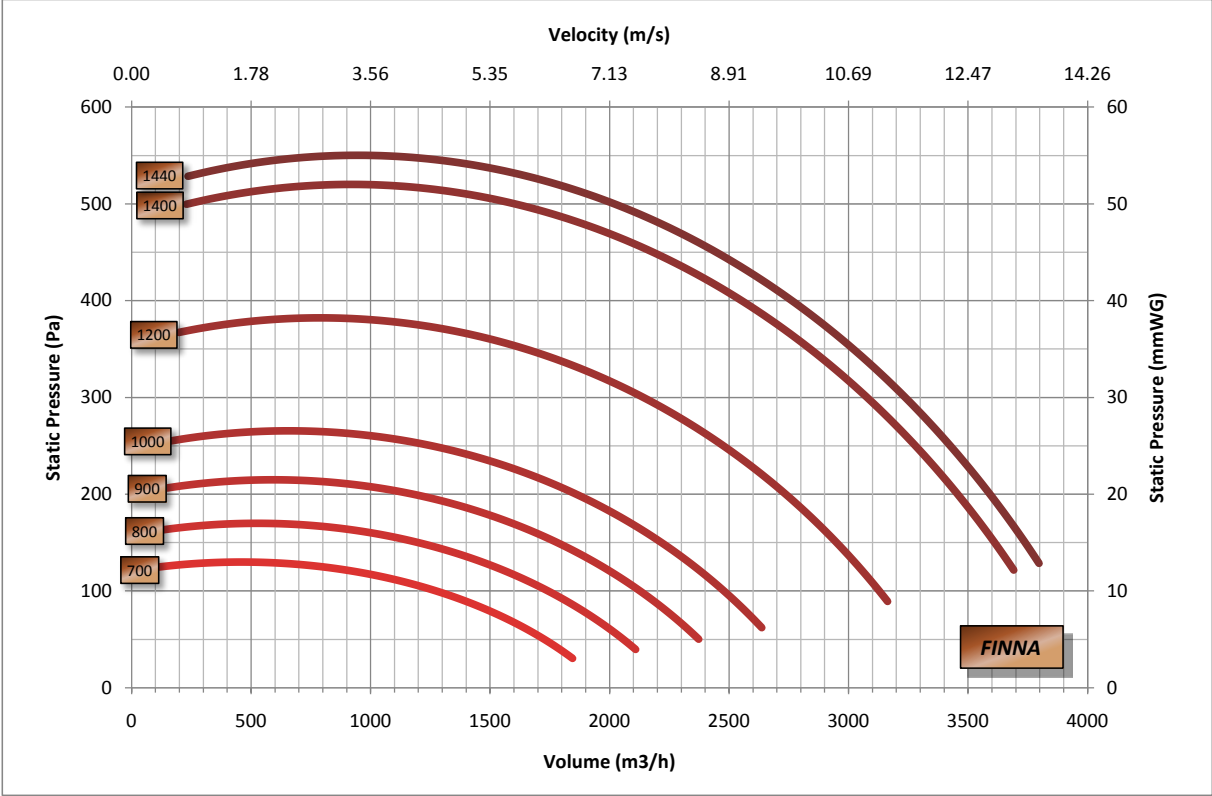

### FIC 315/280 Power / Efficiency Curve

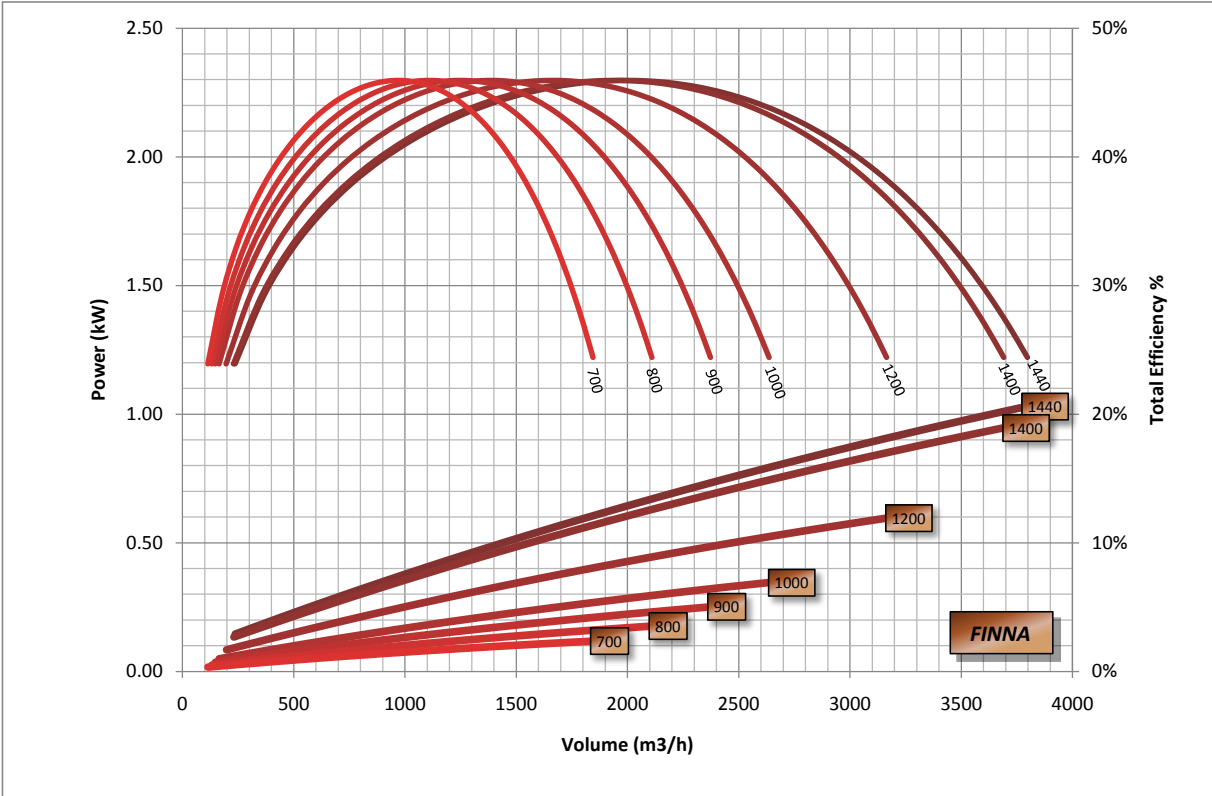

### FIC 315/315 Performance Curve

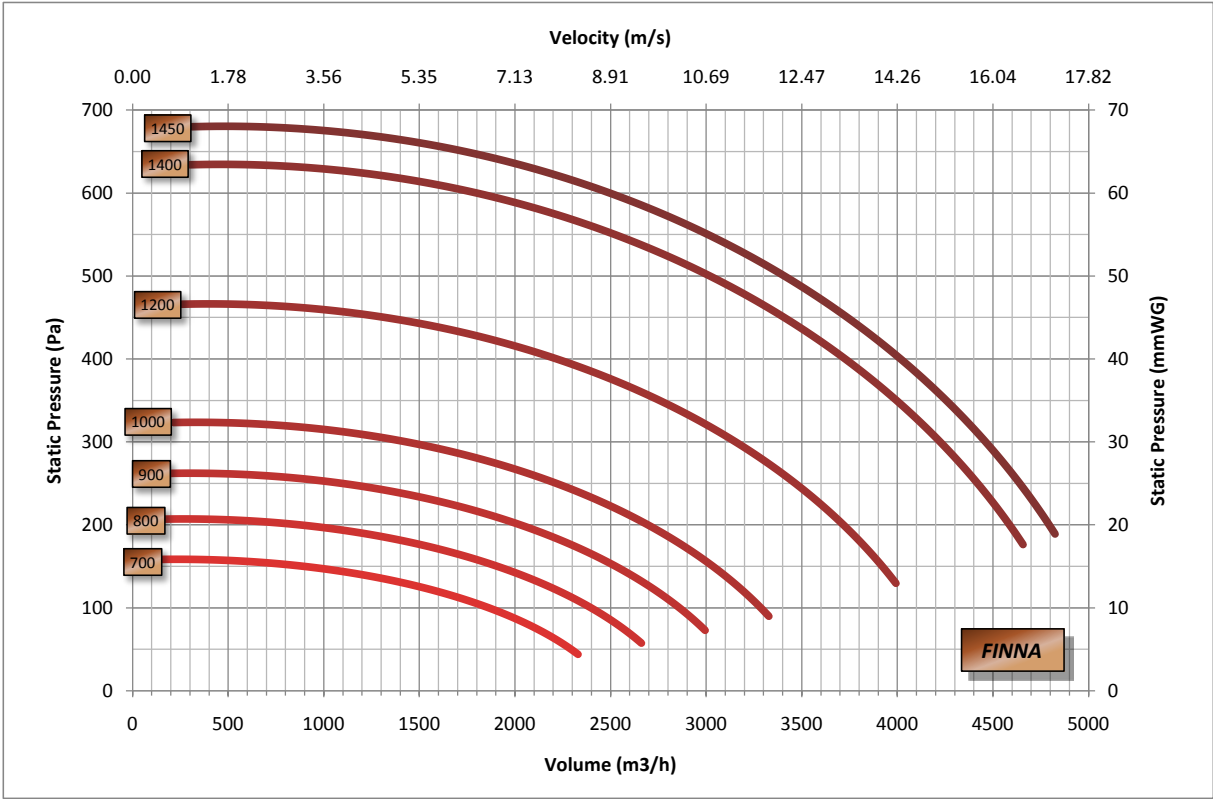

### FIC 315/315 Power / Efficiency Curve

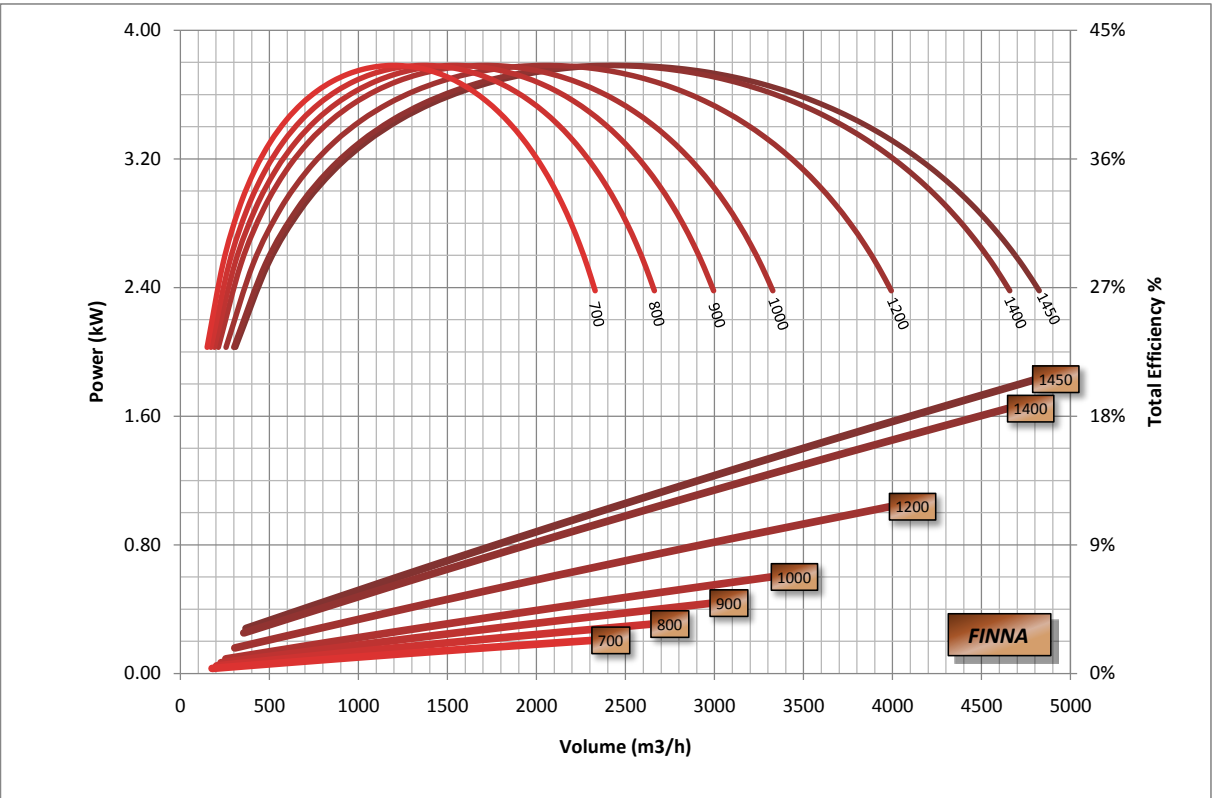

### FIC 400/400 Performance Curve

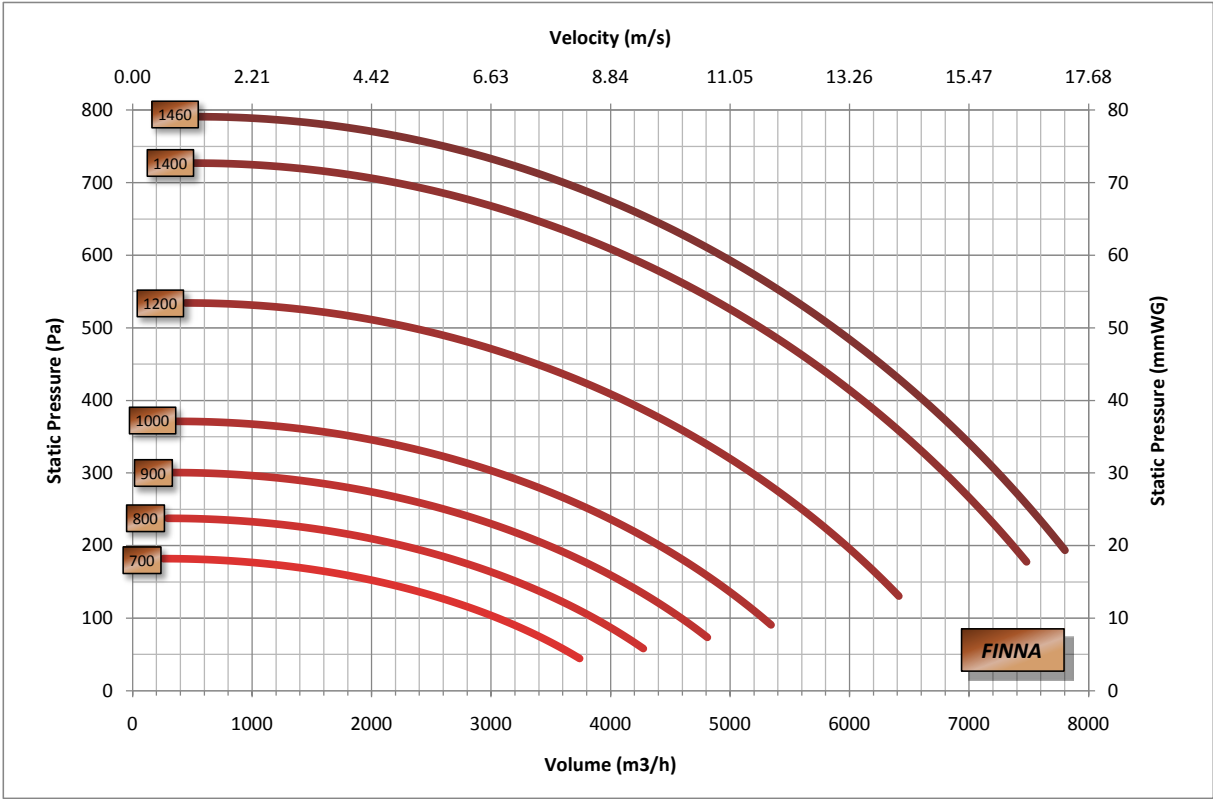

### FIC 400/400 Power / Efficiency Curve

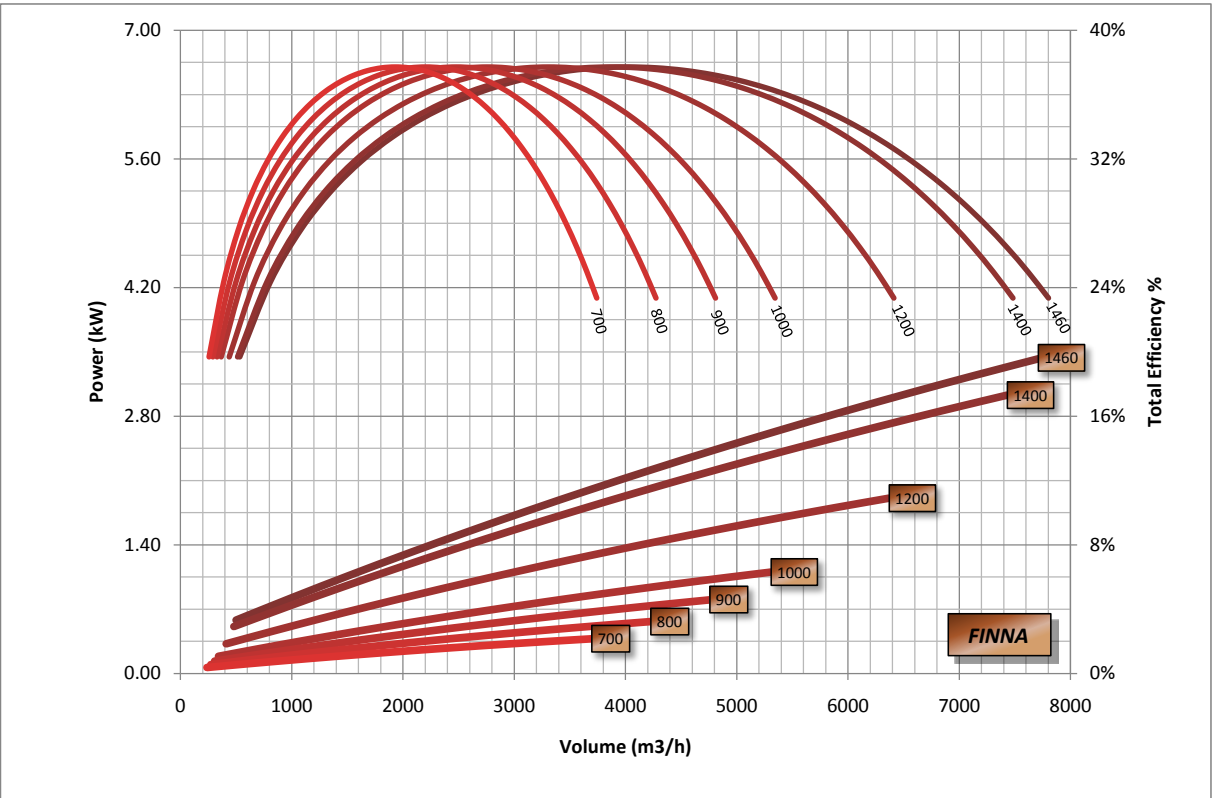



### FIC 450/450 Performance Curve

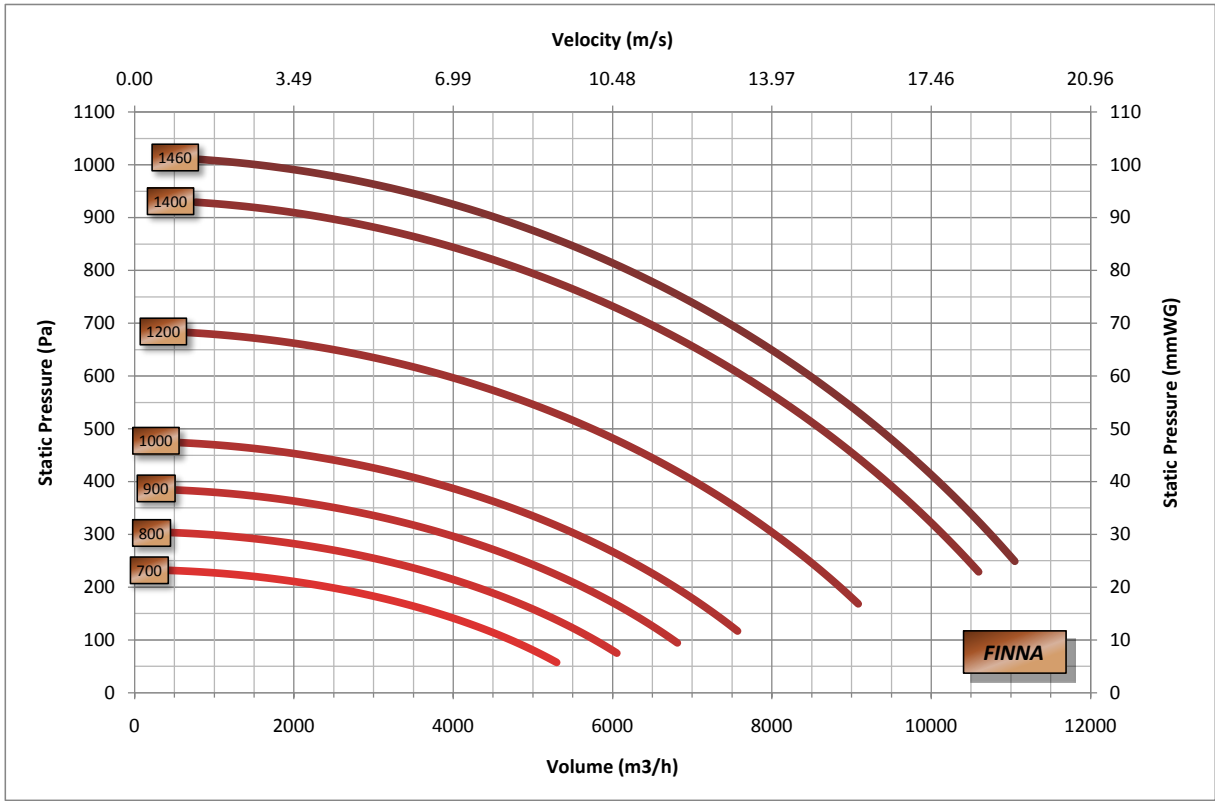

### FIC 450/450 Power / Efficiency Curve

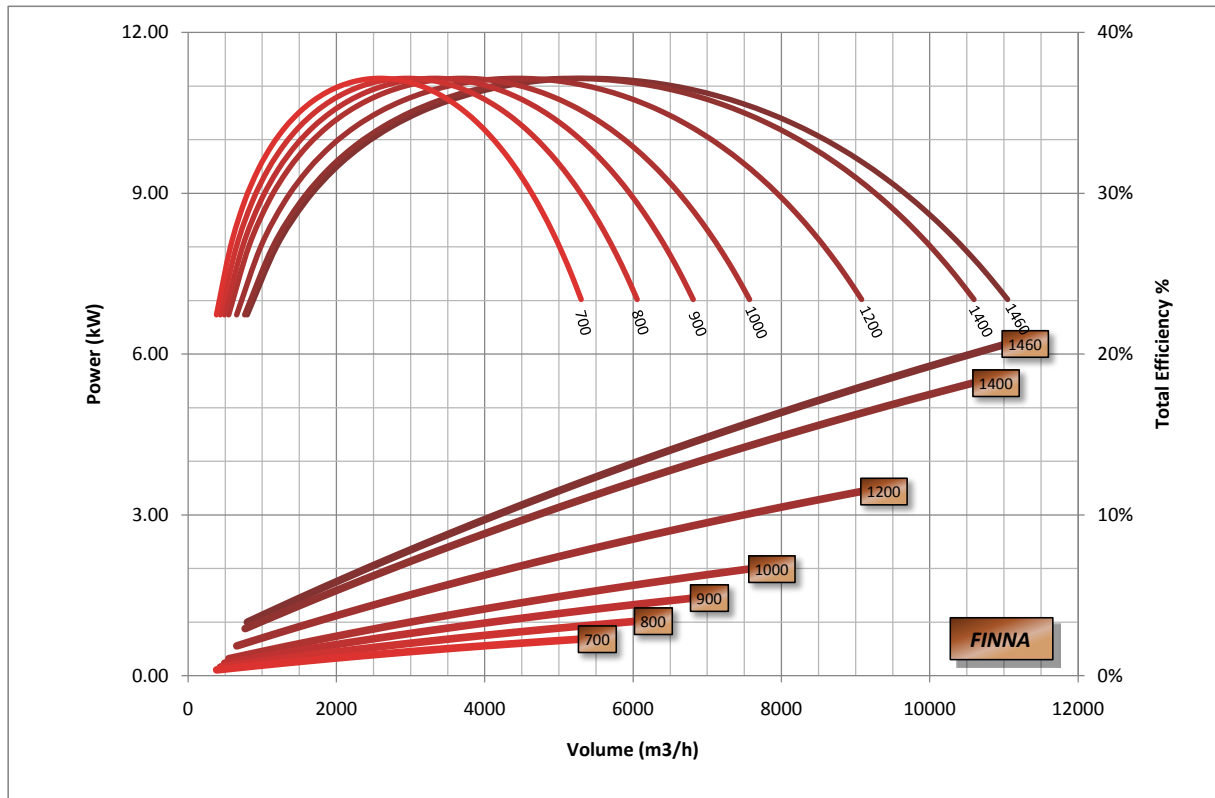

### FIC 500/500 Performance Curve

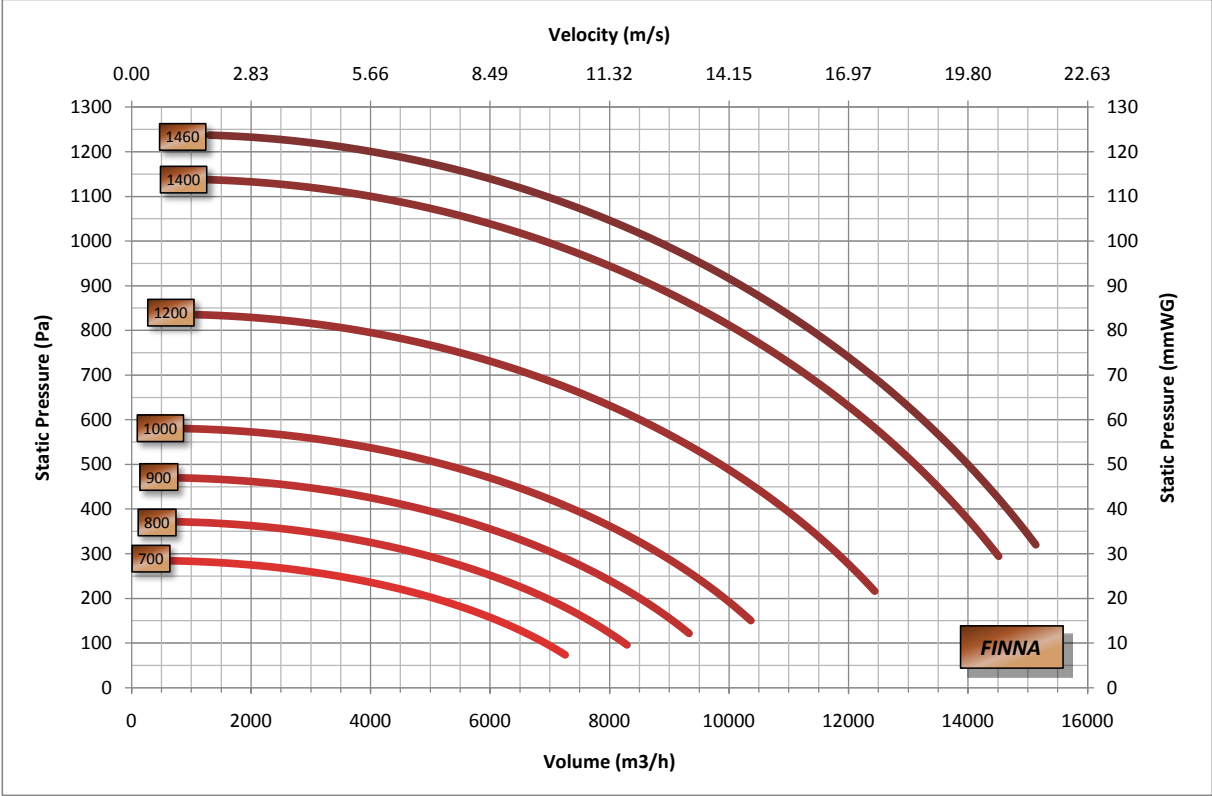

### FIC 500/500 Power / Efficiency Curve

